

KLT-B9MF-IMX577 V1.0**12.3MP Sony IMX577 MIPI Interface M12 Fixed Focus Camera Module**

Front View



Back View

Specifications

Camera Module No.	KLT-B9MF-IMX577 V1.0
Resolution	12.3MP
Image Sensor	IMX577
Sensor Type	1/2.3"
Pixel Size	1.55 um x 1.55 um
EFL	3.0 mm
F.NO	2.80
Pixel	4056 x 3040
View Angle	166°(DFOV) 120°(HFOV) 89°(VFOV)
Lens Dimensions	17.20 x 17.20 x 22.40 mm
Module Size	42.09 x 24.20 mm
Module Type	Fixed Focus
Interface	MIPI
Auto Focus VCM Driver IC	None
Lens Model	KLT-LENS-MJ7016B
Lens Type	650nm IR Cut
Operating Temperature	-20°C to +75°C
Mating Connector	AXE540124



CMOS CAMERA MODULES



your BEST camera module partner

KLT-B9MF-IMX577 V1.0

12.3MP Sony IMX577 MIPI Interface M12 Fixed Focus Camera Module



Top View



Side View



Bottom View



Mating Connector

www.KaiLapTech.com sales@KaiLapTech.com Tel: (852) 6908 1256 Fax: (852) 3017 6778

All rights reserved @ Kai Lap Technologies Group Ltd. Specifications subject to change without notice.

ROHS

PIN SIGNAL

1	SLASEL
2	PWMDN
3	DGND
4	DMO1P
5	DMO1N
6	DGND
7	DMO2P
8	DMO2N
9	DGND
10	DMO3P
11	DMO3N
12	DGND
13	DMO4P
14	DMO4N
15	DGND
16	DCKP
17	DCKN
18	NC
19	NC
20	NC
21	NC
22	NC
23	NC
24	NC
25	SCL
26	SDA
27	DGND
28	INCK
29	DVDD 1.05V
30	DOVDD 1.8V
31	DGND
32	AVDD 2.8V
33	AGND
34	DGND
35	NC
36	NC
37	NC
38	NC
39	DGND
40	DGND

Parameters:

1、Sensor specification:

Image Sensor: IMX577-AAACK-C
 Pixel: 155um×155um
 Lens Type: 1/2.3
 Important Voltage Description: DVDD1.05V
 (External power supply);

2、Lens specification:

FOV: 166° (D); 120° (H); 89° (V)
 F/NO.: 2.8
 TV distortion: <35%
 Focal length: 3mm
 Composition: 7G+IR FILTER
 IR Cut Coating: 650nm±10nm@50%

Version	Information	Date
V1.0	First Version	5-8-2020

Kai Lap Technologies Group Ltd

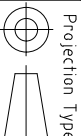
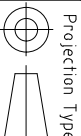
Designed By	Kevin	Model Name:	KLT-B9MF-IMX577 V1.0		
Checked By	Aouly Yan	Projection Type:		Unit:	mm
		Third Angle		Scale:	1:1
				Sheet:	1 of 1
				Version:	1/0

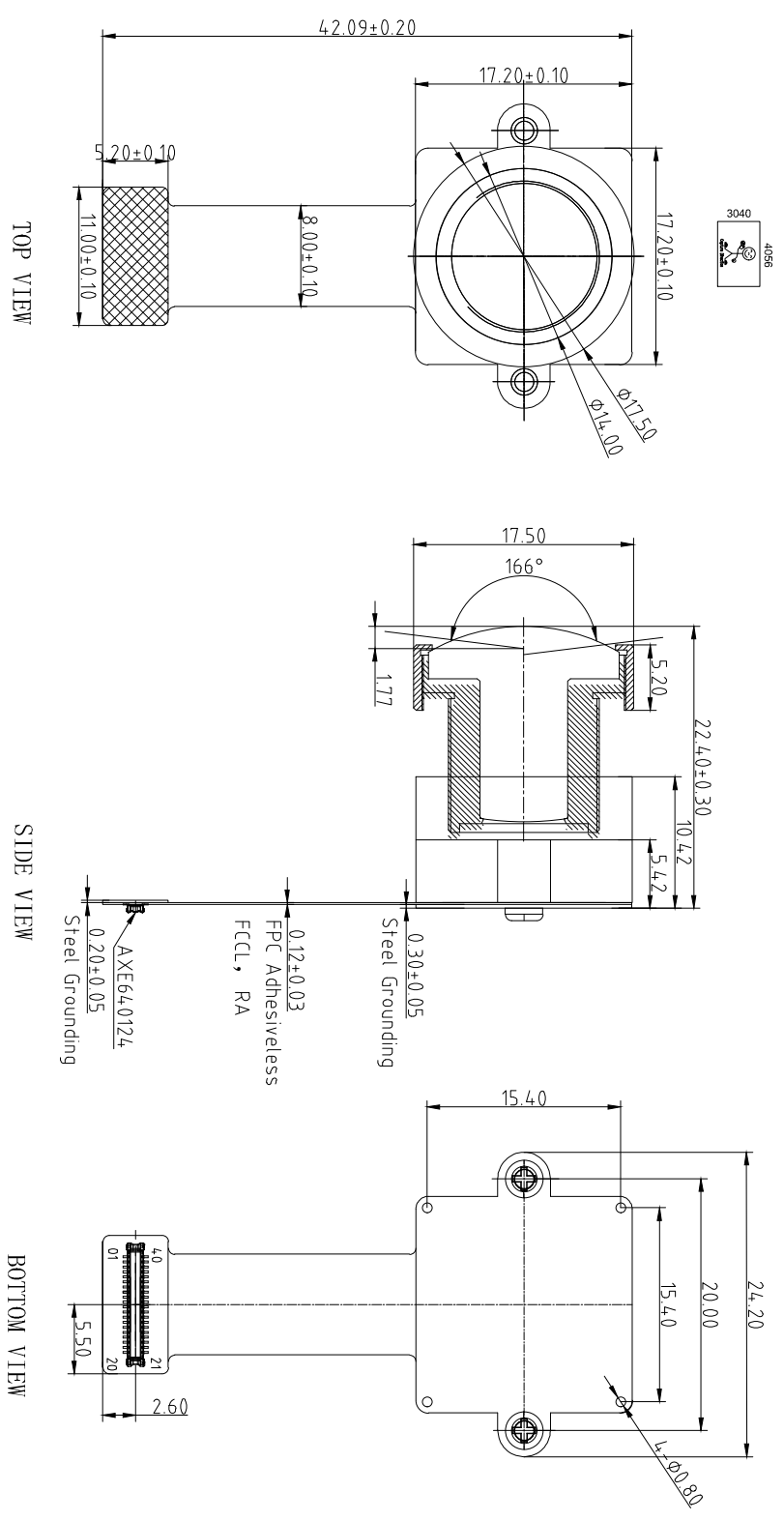

Real Test Images
B9MF-IMX577 V1.0

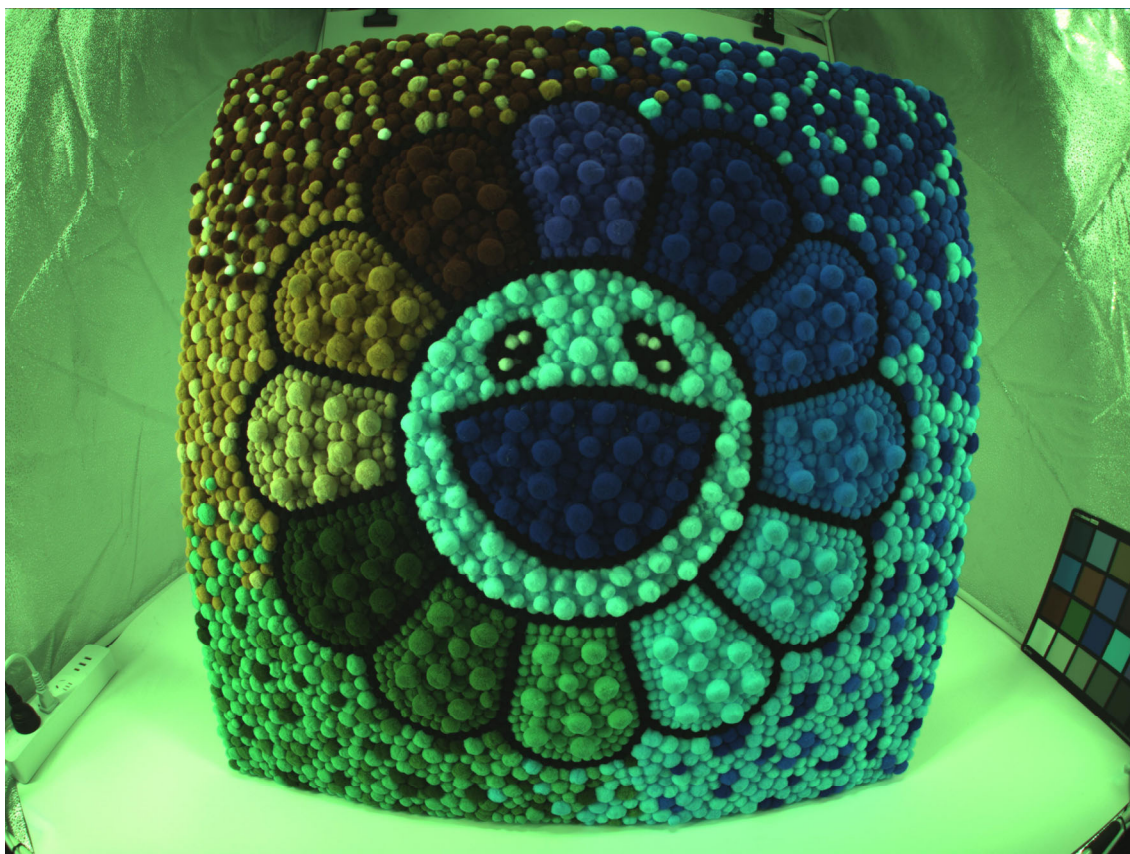

Real Test Images
B9MF-IMX577 V1.0

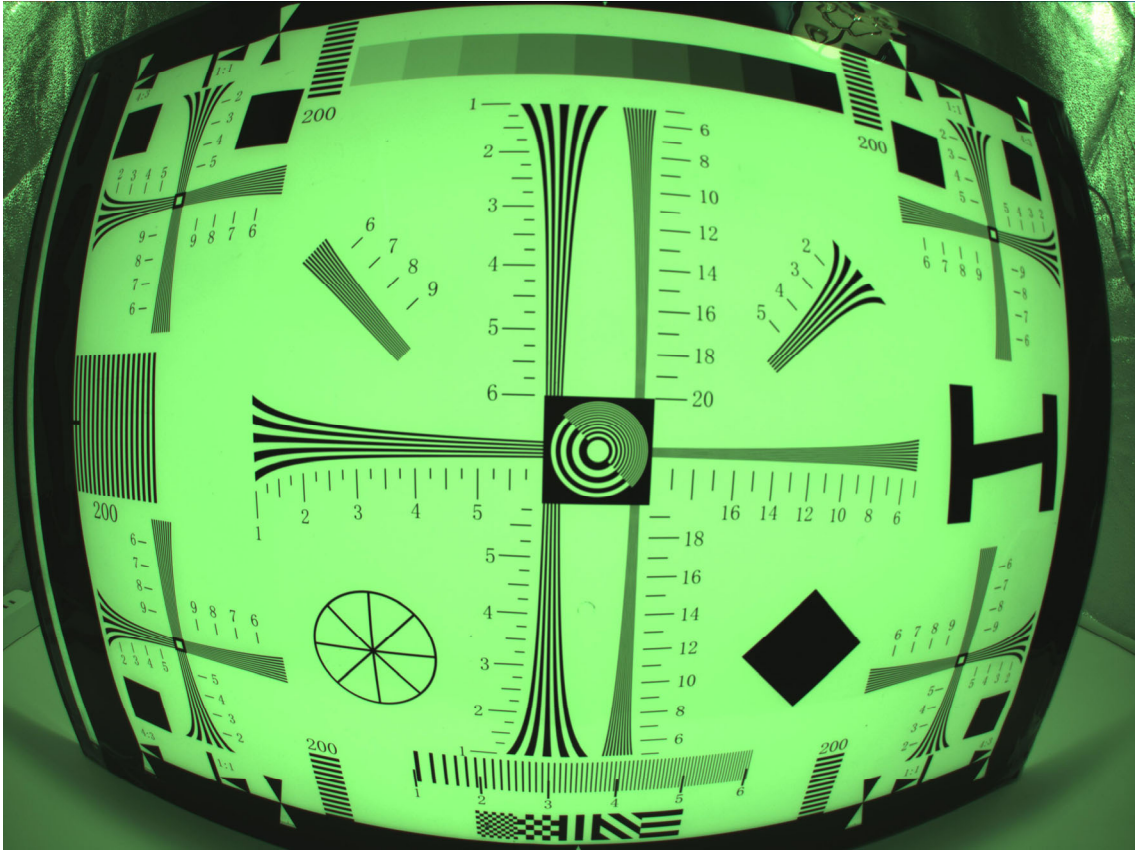

Real Test Images
B9MF-IMX577 V1.0





Lens Model: KLT-LENS-MJ7016B

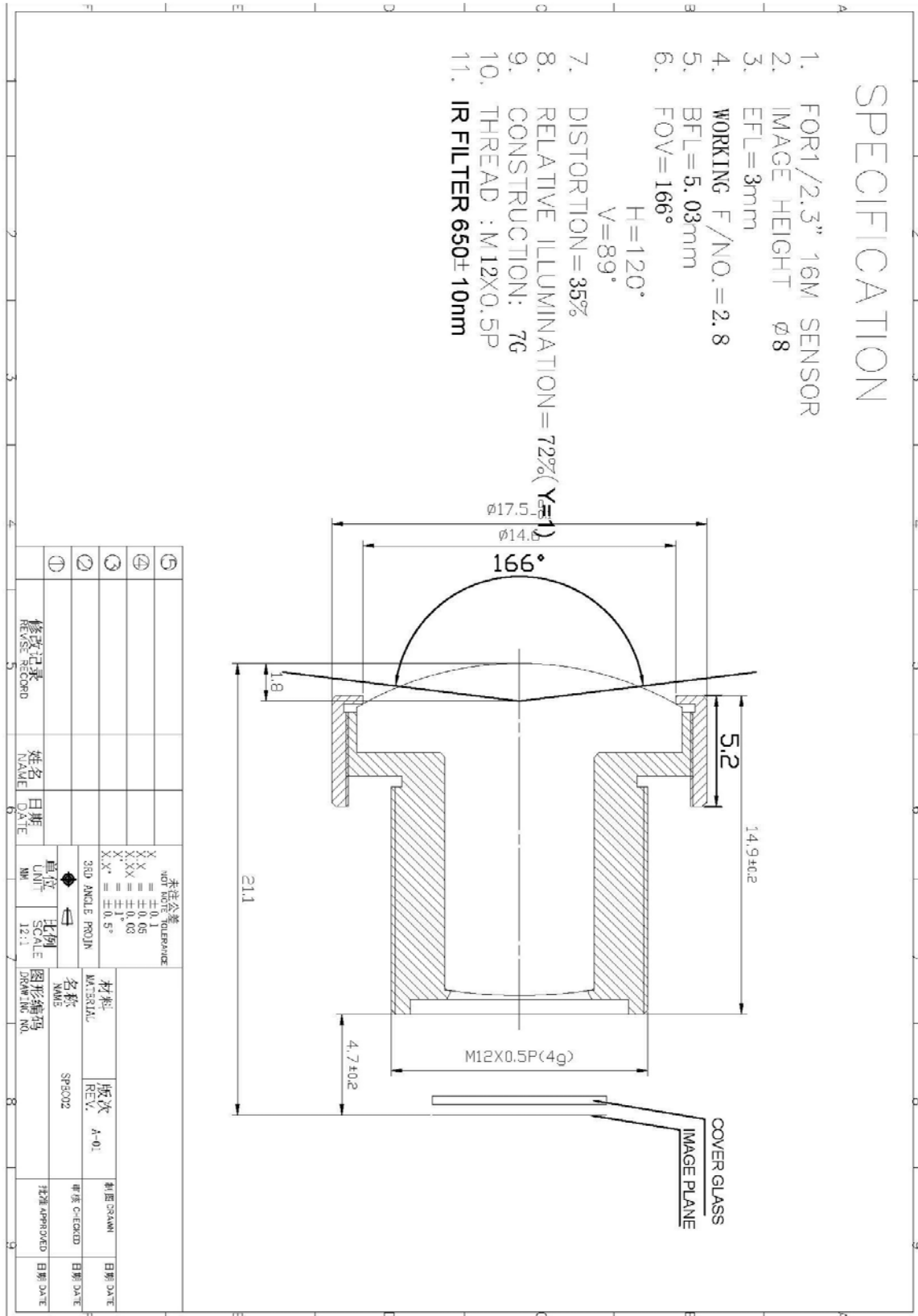

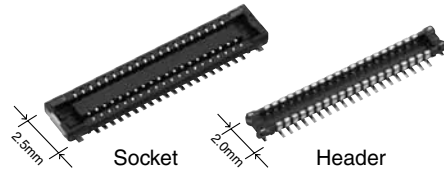

RoHS compliant

For board-to-FPC

Narrow pitch connectors (0.4mm pitch)

A4S Series

FEATURES

- 2.5 mm wide slim two-piece style connectors
Compact and slim structure contributes overall miniaturization of product design. <Compared to F4S series (40 pin contacts, when mated)>
 - Width: 30% down
 - Footprint: 30% down

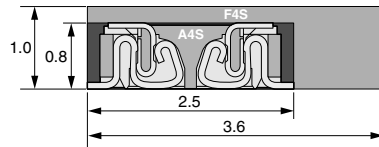

- "TOUGH CONTACT ADVANCED" ensures high resistance to various environments in lieu of slim and low profile body
- Simple lock structure provides tactile feedback to ensure excellent mating/unmating operation feel.

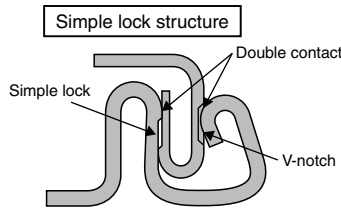

The connector gives the tactile feedback when inserted, allowing reliable mating.

- Mated heights of 0.8 and 1.0 mm are available for the same foot pattern.
- Connectors for inspection available

APPLICATIONS

Recommended for board-to-FPC connections of mobile equipment, such as cellular phones, smart phones, laptops, and portable music players

ORDERING INFORMATION

	AXE				2	4
5: Narrow Pitch Connector A4S (0.4 mm pitch) Socket						
6: Narrow Pitch Connector A4S (0.4 mm pitch) Header						
Number of pins (2 digits)						
Mated height						
<Socket>						
1: For mated height 0.8/1.0 mm						
<Header>						
1: For mated height 0.8 mm						
2: For mated height 1.0 mm						
Functions						
2: Without positioning bosses						
Surface treatment (Contact portion / Terminal portion)						
<Socket>						
4: Ni plating on base, Au plating on surface (for Ni barrier available)						
<Header>						
4: Ni plating on base, Au plating on surface						

PRODUCT TYPES

Mated height	Number of pins	Part number		Packing	
		Socket	Header	Inner carton (1-reel)	Outer carton
0.8mm	10	AXE510124	AXE610124	5,000 pieces	10,000 pieces
	12	AXE512124	AXE612124		
	14	AXE514124	AXE614124		
	16	AXE516124	AXE616124		
	18	AXE518124	AXE618124		
	20	AXE520124	AXE620124		
	22	AXE522124	AXE622124		
	24	AXE524124	AXE624124		
	26	AXE526124	AXE626124		
	28	AXE528124	AXE628124		
	30	AXE530124	AXE630124		
	32	AXE532124	AXE632124		
	34	AXE534124	AXE634124		
	36	AXE536124	AXE636124		
	38	AXE538124	AXE638124		
	40	AXE540124	AXE640124		
	44	AXE544124	AXE644124		
	50	AXE550124	AXE650124		
	54	AXE554124	AXE654124		
	1.0mm	56	AXE556124		
60		AXE560124	AXE660124		
64		AXE564124	AXE664124		
70		AXE570124	AXE670124		
80		AXE580124	AXE680124		
10		AXE510124	AXE610224		
12		AXE512124	AXE612224		
14		AXE514124	AXE614224		
20		AXE520124	AXE620224		
24		AXE524124	AXE624224		
26		AXE526124	AXE626224		
30		AXE530124	AXE630224		
32		AXE532124	AXE632224		
40		AXE540124	AXE640224		
44		AXE544124	AXE644224		
50		AXE550124	AXE650224		
54	AXE554124	AXE654224			
60	AXE560124	AXE660224			
70	AXE570124	AXE670224			
80	AXE580124	AXE680224			

Notes: 1. Order unit:

For volume production: 1-inner carton (1-reel) units

Samples for mounting check: 50-connector units. Please contact our sales office.

Samples: Small lot orders are possible. Please contact our sales office.

- The above part numbers are for connectors without positioning bosses, which are standard. When ordering connectors with positioning bosses, please contact our sales office.
- Please contact us for connectors having a number of pins other than those listed above.

AXE5, 6

SPECIFICATIONS

■ Characteristics

	Item	Specifications	Conditions
Electrical characteristics	Rated current	0.3A/pin contact (Max. 5 A at total pin contacts)	
	Rated voltage	60V AC/DC	
	Breakdown voltage	150V AC for 1 min.	No short-circuiting or damage at a detection current of 1 mA when the specified voltage is applied for one minute.
	Insulation resistance	Min. 1,000MΩ (initial)	Using 250V DC megger (applied for 1 min.)
	Contact resistance	Max. 90mΩ	Based on the contact resistance measurement method specified by JIS C 5402.
Mechanical characteristics	Composite insertion force	Max. 1.200N/pin contacts × pin contacts (initial)	
	Composite removal force	Min. 0.165N/pin contacts × pin contacts	
Environmental characteristics	Contact holding force (Socket contact)	Min. 0.20N/pin contacts	Measuring the maximum force. As the contact is axially pull out.
	Ambient temperature	-55°C to +85°C	No freezing at low temperatures. No dew condensation.
	Soldering heat resistance	Peak temperature: 260°C or less (on the surface of the PC board around the connector terminals) 300°C within 5 sec. 350°C within 3 sec.	Infrared reflow soldering Soldering iron
	Storage temperature	-55°C to +85°C (product only) -40°C to +50°C (emboss packing)	No freezing at low temperatures. No dew condensation.
	Thermal shock resistance (header and socket mated)	5 cycles, insulation resistance min. 100MΩ, contact resistance max. 90mΩ	Sequence 1. -55 ^{±3} °C, 30 minutes 2. ~, Max. 5 minutes 3. 85 ^{±3} °C, 30 minutes 4. ~, Max. 5 minutes
	Humidity resistance (header and socket mated)	120 hours, insulation resistance min. 100MΩ, contact resistance max. 90mΩ	Bath temperature 40±2°C, humidity 90 to 95% R.H.
	Saltwater spray resistance (header and socket mated)	24 hours, insulation resistance min. 100MΩ, contact resistance max. 90mΩ	Bath temperature 35±2°C, saltwater concentration 5±1%
H ₂ S resistance (header and socket mated)	48 hours, contact resistance max. 90mΩ	Bath temperature 40±2°C, gas concentration 3±1 ppm, humidity 75 to 80% R.H.	
Lifetime characteristics	Insertion and removal life	30 times	Repeated insertion and removal speed of max. 200 times/hours
Unit weight		20 pin contact type: Socket: 0.02 g Header: 0.01 g	

■ Material and surface treatment

Part name	Material	Surface treatment
Molded portion	LCP resin (UL94V-0)	—
Contact and Post	Copper alloy	Contact portion: Base: Ni plating Surface: Au plating Terminal portion: Base: Ni plating Surface: Au plating (except the terminal tips) The socket terminals close to the portion to be soldered have nickel barriers (exposed nickel portions). Soldering terminals: Sockets: Base: Ni plating Surface: Pd+Au flash plating (except the terminal tips) Headers: Base: Ni plating Surface: Au plating (except the terminal tips)

DIMENSIONS (Unit: mm)

The CAD data of the products with a **CAD Data** mark can be downloaded from: <http://industrial.panasonic.com/ac/e>

■ Socket (Mated height: 0.8 mm/1.0 mm)

CAD Data

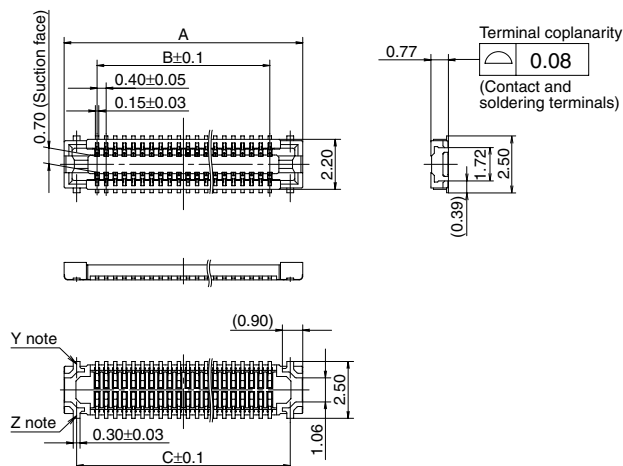
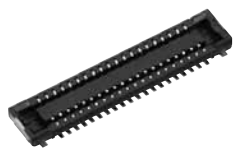

General tolerance: ±0.2

Note: Since the soldering terminals has a single-piece construction, sections Y and Z are electrically connected.

Dimension table (mm)

Number of pins/dimension	A	B	C
10	4.5	1.6	3.4
12	4.9	2.0	3.8
14	5.3	2.4	4.2
16	5.7	2.8	4.6
18	6.1	3.2	5.0
20	6.5	3.6	5.4
22	6.9	4.0	5.8
24	7.3	4.4	6.2
26	7.7	4.8	6.6
28	8.1	5.2	7.0
30	8.5	5.6	7.4
32	8.9	6.0	7.8
34	9.3	6.4	8.2
36	9.7	6.8	8.6
38	10.1	7.2	9.0
40	10.5	7.6	9.4
44	11.3	8.4	10.2
50	12.5	9.6	11.4
54	13.3	10.4	12.2
56	13.7	10.8	12.6
60	14.5	11.6	13.4
64	15.3	12.4	14.2
70	16.5	13.6	15.4
80	18.5	15.6	17.4

■ Header (Mated height: 0.8 mm)

CAD Data

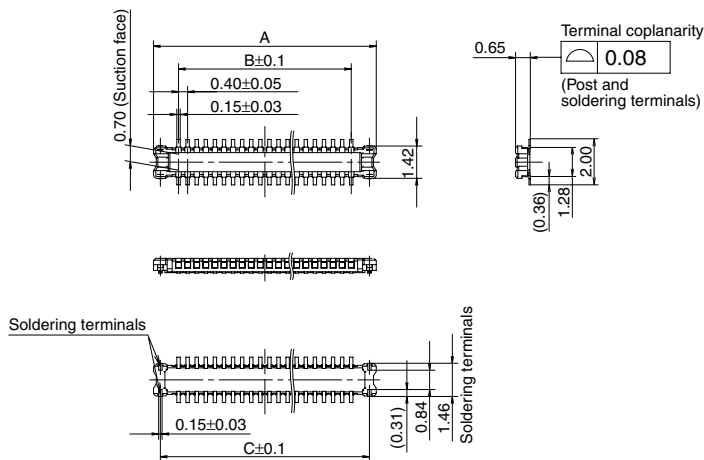

General tolerance: ±0.2

Dimension table (mm)

Number of pins/dimension	A	B	C
10	3.8	1.6	3.2
12	4.2	2.0	3.6
14	4.6	2.4	4.0
16	5.0	2.8	4.4
18	5.4	3.2	4.8
20	5.8	3.6	5.2
22	6.2	4.0	5.6
24	6.6	4.4	6.0
26	7.0	4.8	6.4
28	7.4	5.2	6.8
30	7.8	5.6	7.2
32	8.2	6.0	7.6
34	8.6	6.4	8.0
36	9.0	6.8	8.4
38	9.4	7.2	8.8
40	9.8	7.6	9.2
44	10.6	8.4	10.0
50	11.8	9.6	11.2
54	12.6	10.4	12.0
56	13.0	10.8	12.4
60	13.8	11.6	13.2
64	14.6	12.4	14.0
70	15.8	13.6	15.2
80	17.8	15.6	17.2

[Product Information]

Ver.1.0

IMX577-AACK

Diagonal 7.857 mm (Type 1/2.3) 12.3 Mega-Pixel CMOS Image Sensor with Square Pixel for Color Cameras

Description

The IMX577-AACK is a diagonal 7.857 mm (Type 1/2.3) 12.3 Mega-pixel CMOS active pixel type stacked image sensor with a square pixel array. It adopts Sony's Stacked CMOS Image Sensor technology to achieve high speed image capturing by column parallel A/D converter circuits and high sensitivity and low noise image (comparing with conventional CMOS image sensor) through the backside illuminated imaging pixel structure. R, G, and B pigment primary color mosaic filter is employed. It equips an electronic shutter with variable integration time. It operates with three power supply voltages: analog 2.8 V, digital 1.05 V and 1.8 V for input/output interface and achieves low power consumption.

In addition, this product is designed for use in consumer use camcorder. When using this for another application, Sony Semiconductor Solutions Corporation does not guarantee the quality and reliability of product. Therefore, don't use this for applications other than consumer use camcorder.

In addition, individual specification change cannot be supported because this is a standard product.

Consult your Sony Semiconductor Solutions Corporation sales representative if you have any questions.

Features

- ◆ Back-illuminated and stacked CMOS image sensor
- ◆ Digital Overlap High Dynamic Range (DOL-HDR) mode with raw data output.
- ◆ High signal to noise ratio (SNR).
- ◆ Full resolution @60 frame/s (Normal), 4K2K @60 frame/s (Normal), 1080p @240 frame/s
Full resolution @40 frame/s (12 bit Normal), Full resolution @30 frame/s (DOL-HDR, 2 frame)
- ◆ Output video format of RAW12/10/8, COMP8.
- ◆ Power Save Mode with MIPI ULPS operation
- ◆ Pixel binning readout and V sub-sampling function.
- ◆ Independent flipping and mirroring.
- ◆ Input clock frequency 6 to 27 MHz
- ◆ CSI-2 serial data output (MIPI 2lane/4lane, Max. 2.1 Gbps/lane, D-PHY spec. ver. 1.2 compliant)
- ◆ 2-wire serial communication.
- ◆ Two PLLs for independent clock generation for pixel control and data output interface.
- ◆ Defect Pixel Correction (DPC)
- ◆ Ambient Light Sensor (ALS)
- ◆ Fast mode transition. (on the fly)
- ◆ Dual sensor synchronization operation (Multi camera compatible)
- ◆ 7 k bit of OTP ROM for users.
- ◆ Built-in temperature sensor
- ◆ 10-bit/12-bit A/D conversion on chip
- ◆ Horizontal Low Power Analog Cropping
- ◆ Window Scanning mode
- ◆ 92-pin high-precision ceramic package

Sony reserves the right to change products and specifications without prior notice.

Sony logo is a registered trademark of Sony Corporation.

Device Structure

◆ CMOS image sensor	
◆ Image size	Diagonal 7.857 mm (Type 1/2.3)
◆ Total number of pixels	4072 (H) × 3176 (V) approx. 12.93 M pixels
◆ Number of effective pixels	4072 (H) × 3064 (V) approx. 12.47 M pixels
◆ Number of active pixels	4056 (H) × 3040 (V) approx. 12.33 M pixels
◆ Chip size	7.564 mm (H) × 5.476 mm (V)
◆ Unit cell size	1.55 μm (H) × 1.55 μm (V)
◆ Package	92 pin LGA

Image Sensor Characteristics

(T_j = 60 °C)

Item		Value	Remarks
Sensitivity (F2.8)	Min.	250 LSB	1/120 s integration
Saturation signal	Min.	1023 LSB	

Basic Drive Mode

Drive mode	Number of active pixels	Maximum frame rate [frame/s]	Output interface	ADC [bit]
Full (4:3) (Normal)	4056 (H) × 3040 (V) approx. 12.33 M pixels	60	CSI-2	10
		43	CSI-2	12
Full (4:3) (DOL-HDR)	4056 (H) × 3040 (V) approx. 12.33 M pixels	DOL 2 frame : 30 DOL 3 frame : 15	CSI-2	10
Full (16:9) 4K2K (Normal)	4056 (H) × 2288 (V) approx. 9.28 M pixels	79	CSI-2	10
Full (16:9) 4K2K (DOL-HDR)	4056 (H) × 2288 (V) approx. 9.28 M pixels	DOL 2 frame : 39 DOL 3 frame : 19	CSI-2	10
Full (4:3) Binning (Normal)	2028 (H) × 1520 (V) approx. 3.08 M pixels	178	CSI-2	10
Full (16:9) Binning 1080P (Normal)	2028 (H) × 1112 (V) approx. 2.26 M pixels	241	CSI-2	10
Full (16:9) Binning 720P (Normal)	1352 (H) × 740 (V) approx. 1.00 M pixels	241	CSI-2	10
Full (16:9) Scaling 1080P (Normal)	2028 (H) × 1144 (V) approx. 2.32 M pixels	79	CSI-2	10
Full (16:9) Scaling 720P (Normal)	1352 (H) × 762 (V) approx. 1.03 M pixels	79	CSI-2	10



Camera Module Pinout Definition Reference Chart

OmniVision	Sony	Samsung	On-Semi	Aptina	Himax	GalaxyCore	PixArt	SmartSens	Sensors	
Pin Signal										
Description										
DGND	GND									ground for digital circuit
AGND										ground for analog circuit
PCLK	DCK									DVP PCLK output
XCLR	PWDN	XSHUTDOWN	STANDBY							power down active high with internal pull-down resistor
MCLK	XVCLK	XCLK	INCK							system input clock
RESET	RST									reset active low with internal pull-up resistor
NC	NULL									no connect
SDA	SIO_D	SIOD								SCCB data
SCL	SIO_C	SIOC								SCCB input clock
VSYNC	XVS	FSYNC								DVP VSYNC output
HREF	XHS									DVP HREF output
DOVDD										power for I/O circuit
AFVDD										power for VCM circuit
AVDD										power for analog circuit
DVDD										power for digital circuit
STROBE	FSTROBE									strobe output
FSIN										synchronize the VSYNC signal from the other sensor
SID										SCCB last bit ID input
ILPWM										mechanical shutter output indicator
FREX										frame exposure / mechanical shutter
GPIO										general purpose inputs
SLASEL										I2C slave address select
AFEN										CEN chip enable active high on VCM driver IC
MIPI Interface										
MDN0	DN0	MD0N	DATA_N	DMO1N						MIPI 1st data lane negative output
MDP0	DP0	MD0P	DATA_P	DMO1P						MIPI 1st data lane positive output
MDN1	DN1	MD1N	DATA2_N	DMO2N						MIPI 2nd data lane negative output
MDP1	DP1	MD1P	DATA2_P	DMO2P						MIPI 2nd data lane positive output
MDN2	DN2	MD2N	DATA3_N	DMO3N						MIPI 3rd data lane negative output
MDP2	DP2	MD2P	DATA3_P	DMO3P						MIPI 3rd data lane positive output
MDN3	DN3	MD3N	DATA4_N	DMO4N						MIPI 4th data lane negative output
MDP3	DP3	MD3P	DATA4_P	DMO4P						MIPI 4th data lane positive output
MCN	CLKN	CLK_N	DCKN							MIPI clock negative output
MCP	CLKP	MCP	CLK_P	DCKN						MIPI clock positive output
DVP Parallel Interface										
D0	DO0	Y0								DVP data output port 0
D1	DO1	Y1								DVP data output port 1
D2	DO2	Y2								DVP data output port 2
D3	DO3	Y3								DVP data output port 3
D4	DO4	Y4								DVP data output port 4
D5	DO5	Y5								DVP data output port 5
D6	DO6	Y6								DVP data output port 6
D7	DO7	Y7								DVP data output port 7
D8	DO8	Y8								DVP data output port 8
D9	DO9	Y9								DVP data output port 9
D10	DO10	Y10								DVP data output port 10
D11	DO11	Y11								DVP data output port 11



your **BEST** camera module partner

Cameras Applications





Camera Reliability Test

Reliability Inspection Item		Testing Method	Acceptance Criteria	
Category	Item			
Environmental	Storage Temperature	High 60°C 96 Hours	Temperature Chamber	No Abnormal Situation
		Low -20°C 96 Hours	Temperature Chamber	No Abnormal Situation
	Operation Temperature	High 60°C 24 Hours	Temperature Chamber	No Abnormal Situation
		Low -20°C 24 Hours	Temperature Chamber	No Abnormal Situation
	Humidity	60°C 80% 24 Hours	Temperature Chamber	No Abnormal Situation
	Thermal Shock	High 60°C 0.5 Hours Low -20°C 0.5 Hours Cycling in 24 Hours	Temperature Chamber	No Abnormal Situation
Physical	Drop Test (Free Falling)	Without Package 60cm	10 Times on Wood Floor	Electrically Functional
		With Package 60cm	10 Times on Wood Floor	Electrically Functional
	Vibration Test	50Hz X-Axis 2mm 30min	Vibration Table	Electrically Functional
		50Hz Y-Axis 2mm 30min	Vibration Table	Electrically Functional
		50Hz Z-Axis 2mm 30min	Vibration Table	Electrically Functional
	Cable Tensile Strength Test	Loading Weight 4 kg 60 Seconds Cycling in 24 Hours	Tensile Testing Machine	Electrically Functional
Electrical	ESD Test	Contact Discharge 2 KV	ESD Testing Machine	Electrically Functional
		Air Discharge 4 KV	ESD Testing Machine	Electrically Functional
	Aging Test	On/Off 30 Seconds Cycling in 24 Hours	Power Switch	Electrically Functional
	USB Connector	On/Off 250 Times	Plug and Unplug	Electrically Functional





Inspection Item		Inspection Method	Standard of Inspection		
Category	Item				
Appearance	FPC/ PCB	Color	The Naked Eye	Major Difference is Not Allowed.	
		Be Torn/Chopped	The Naked Eye	Copper Crack Exposure is Not Allowed.	
		Marking	The Naked Eye	Clear, Recognizable (Within 30cm Distance)	
	Holder	Scratches	The Naked Eye	The Inside Crack Exposure is Not Allowed	
		Gap	The Naked Eye	Meet the Height Standard	
		Screw	The Naked Eye	Make Sure Screws Are Presented (If Any)	
		Damage	The Naked Eye	The Inside Crack Exposure is Not Allowed	
	Lens	Scratch	The Naked Eye	No Effect On Resolution Standard	
		Contamination	The Naked Eye	No Effect On Resolution Standard	
		Oil Film	The Naked Eye	No Effect On Resolution Standard	
		Cover Tape	The Naked Eye	No Issue On Appearance.	
	Function	Image	No Communication	Test Board	Not Allowed
			Bright Pixel	Black Board	Not Allowed In the Image Center
Dark Pixel			White board	Not Allowed In the Image Center	
Blurry			The Naked Eye	Not Allowed	
No Image			The Naked Eye	Not Allowed	
Vertical Line			The Naked Eye	Not Allowed	
Horizontal Line			The Naked Eye	Not Allowed	
Light Leakage			The Naked Eye	Not Allowed	
Blinking Image			The Naked Eye	Not Allowed	
Bruise			Inspection Jig	Not Allowed	
Resolution			Chart	Follows Outgoing Inspection Chart Standard	
Color			The Naked Eye	No Issue	
Noise			The Naked Eye	Not Allowed	
Corner Dark			The Naked Eye	Less Than 100px By 100px	
Color Resolution			The Naked Eye	No Issue	
Dimension	Height	The Naked Eye	Follows Approval Data Sheet		
	Width	The Naked Eye	Follows Approval Data Sheet		
	Length	The Naked Eye	Follows Approval Data Sheet		
	Overall	The Naked Eye	Follows Approval Data Sheet		



KLT Package Solutions

KLT Camera Module

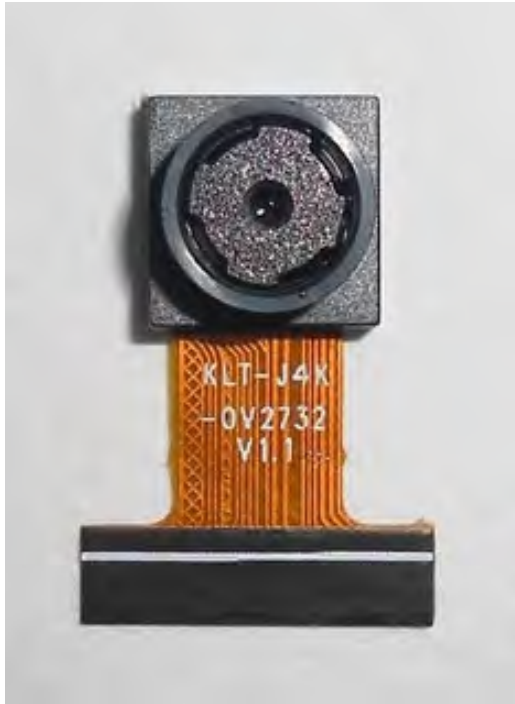

Complete with Lens Protection Film



Tray with Grid and Space



Place Cameras on the Tray

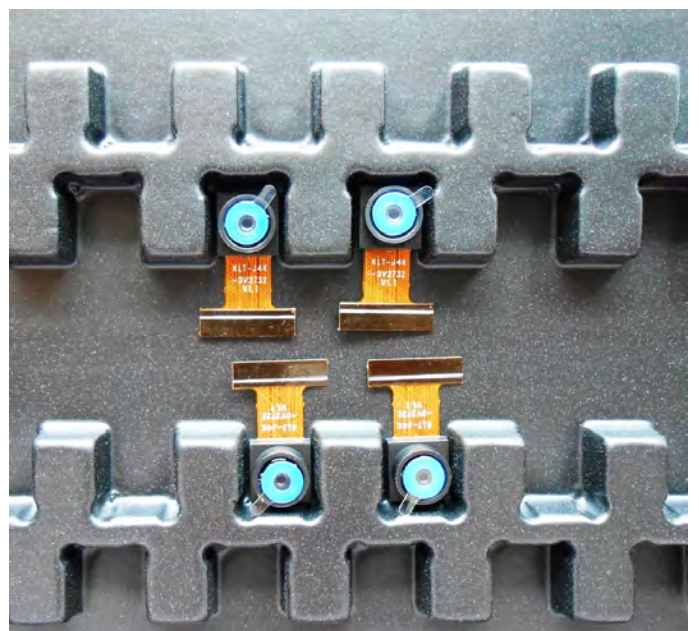



Camera Modules Package Solution

Full Tray of Cameras



Cover Tray with Lid



Put Tray into Anti-Static Bag



Vacuum the Anti-Static Bag

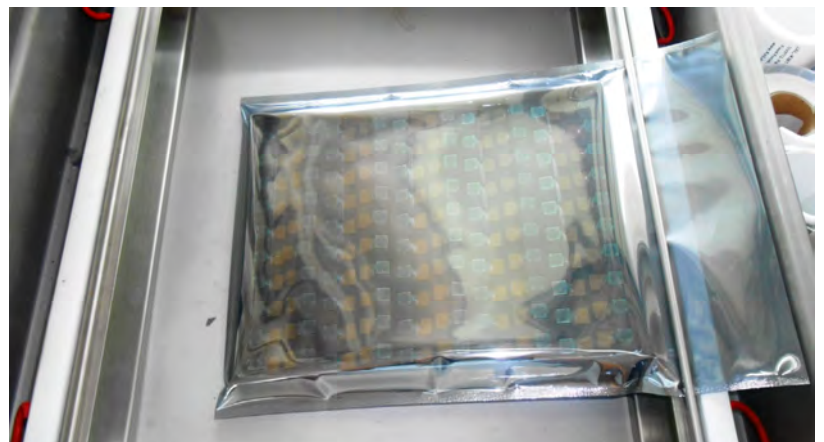



Camera Modules Package Solution

Sealed Vacuum Bag with Labels

1. Model and Description 2. Quantity 3. Shipping Date 4. Caution





Large Order Package Solution

Place Foam Sheets Between Trays



Foam Sheets are Slightly Larger than Trays



Place Foam Sheets and Trays into Box



Foam Sheets are Tightly Fitting Box





Small Order Package Solution

Place Foam Sheets and Trays into Small Box



Foam Sheets are Nicely Fitting the Small Box



Package in Small Box for Shipment



Place Small Boxes into Larger Box





your BEST camera module partner

Carbon Box Package Solution

Seal the Carbon Box

Final Package Labelled Box



Carbon Box Ready for Shipment

1. Delivery Address and Phone No. 2. Box No. and Ship Date 3. Fragile Caution





Sample Order Package Solution

Place Sample into Small Anti-Static Bag



Place Connectors into Small Ant-Static Bag



Sample Labels on the Small Bag

1. Camera Module or Connector Model
2. Shipping Date and Quantity
3. Caution





Connectors Large Order Package Solution

Connectors in a Wheel



Label Connectors in the Wheel



The Wheel is Perfectly Fitting the Box



Connectors Box Ready for Shipment





Company Kai Lap Technologies (KLT)

Kai Lap Technologies Group Limited. (KLT) was established in 2009, a next-generation technology driven manufacturer specialized in research, design, and produce of audio and video products. KLT is occupying 20,000 square feet automated plants with 100 employees of annual throughput 30,000,000 units cameras.

KLT provides OEM, ODM design, contract manufacturing, and builds the camera products. You may provide the requirements to us, even with a hand draft, our sales and engineering work together to meet your needs. We consider ourselves your last-term partner in developing practical and innovative solutions.

Our team covers everything from initial concept development to mass produced product. KLT specializes in customized camera design, raw material, electronic engineering, firmware/software development, product testing, and packing design. Our experienced strategic supply systems offer a robust and dependable manufacturing capacity for orders of various sizes.

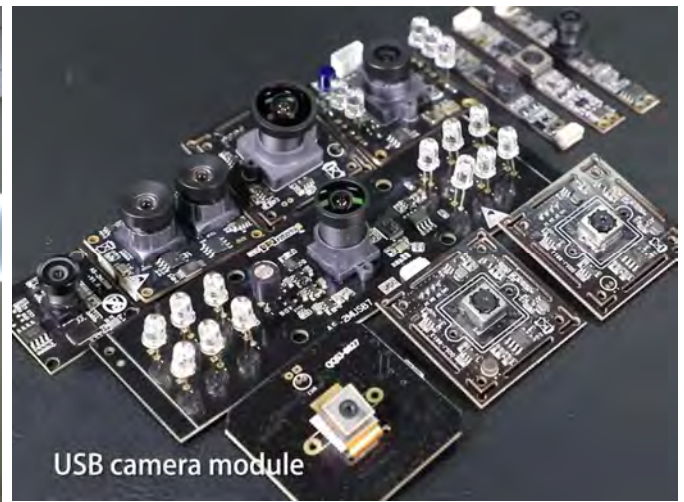

Limited Warranty

KLT provides the following limited warranty if you purchased the Product(s) directly from KLT company or from KLT's website, www.KaiLapTech.com. Product(s) purchased from other sellers or sources are not covered by this Limited Warranty. KLT guarantees that the Product(s) will be free from defects in materials and workmanship under normal use for a period of one (1) year from the date you receive the product ("Warranty Period").

For all Product(s) that contain or develop material defects in materials or workmanship during the Warranty Period, KLT will, at its sole option, either: (i) repair the Product(s); (ii) replace the Product(s) with a new or refurbished Product(s) (replacement Product(s) being of identical model or functional equivalent); or (iii) provide you a refund of the price you paid for the Product(s).

This Limited Warranty of KLT is solely limited to repair and/or replacement on the terms set forth above. KLT is not reliable or responsible for any subsequent events.





CMOS CAMERA MODULES



your BEST camera module partner

KLT Strength

Powerful Factory



Professional Service



Promised Delivery



www.KaiLapTech.com sales@KaiLapTech.com Tel: (852) 6908 1256 Fax: (852) 3017 6778

All rights reserved @ Kai Lap Technologies Group Ltd. Specifications subject to change without notice.